

# Circuit Building and Programming with Teensy in Arduino

Nick Marchuk

9/4/2019

A digital version of this document can be found at

<http://hades.mech.northwestern.edu/images/0/01/CircuitBuildingAndProgrammingWithTeensyInArduino.pdf>

## Tutorial Parts List:

[Storage box](#)

[Breadboard](#)

[6 colors of 24 gauge solid core wire](#)

[Wire strippers](#)

[Teensy 3.5](#) with pins already soldered on

[Micro USB cable](#)

([USB C to USB2 adapter](#))

[Neopixel \(WS2812B\) breakout board](#)

[10k potentiometer](#)

[330 \$\Omega\$](#) , [10k \$\Omega\$](#)  resistors

[Red](#), [green](#), [yellow](#) LEDs

[Push button](#)

[Micro RC Servo](#) with header pins to stick in the plug

[Audio amplifier](#)

[Speaker](#)

[Accelerometer](#)

## Software for the Arduino Integrated Design Environment (IDE) and Teensy add-on:

Visit <https://www.arduino.cc/en/Main/Software> and download the installer for Arduino 1.8.9. Install it in the default location. Run the Arduino program once, then exit. (Do not install from the Windows Store, this version does not work with the Teensyduino add-on).

Visit [https://www.pjrc.com/teensy/td\\_download.html](https://www.pjrc.com/teensy/td_download.html) and download the installer for Teensyduino 1.47. Install it in the default location.

## Electronics: Cut and strip a wire



Practice using your wire strippers to cut a few 1" long wires. Remove about  $\frac{1}{4}$ " of insulation from both ends of the wire, using the 26 AWG stripper hole.  $\frac{1}{4}$ " of exposed wire is about the right length to be plugged into the breadboard without leaving any exposed wire to accidentally touch other exposed wires (the breadboard is about  $\frac{1}{4}$ " deep).

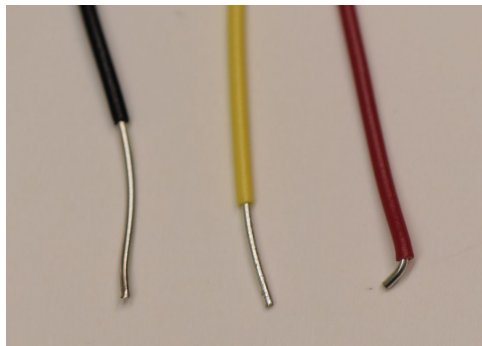

Too much wire exposed (left), too little (right), goldilocks (center)

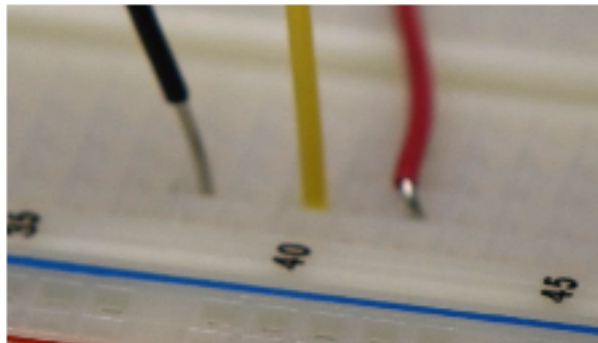

## Electronics: How a breadboard works

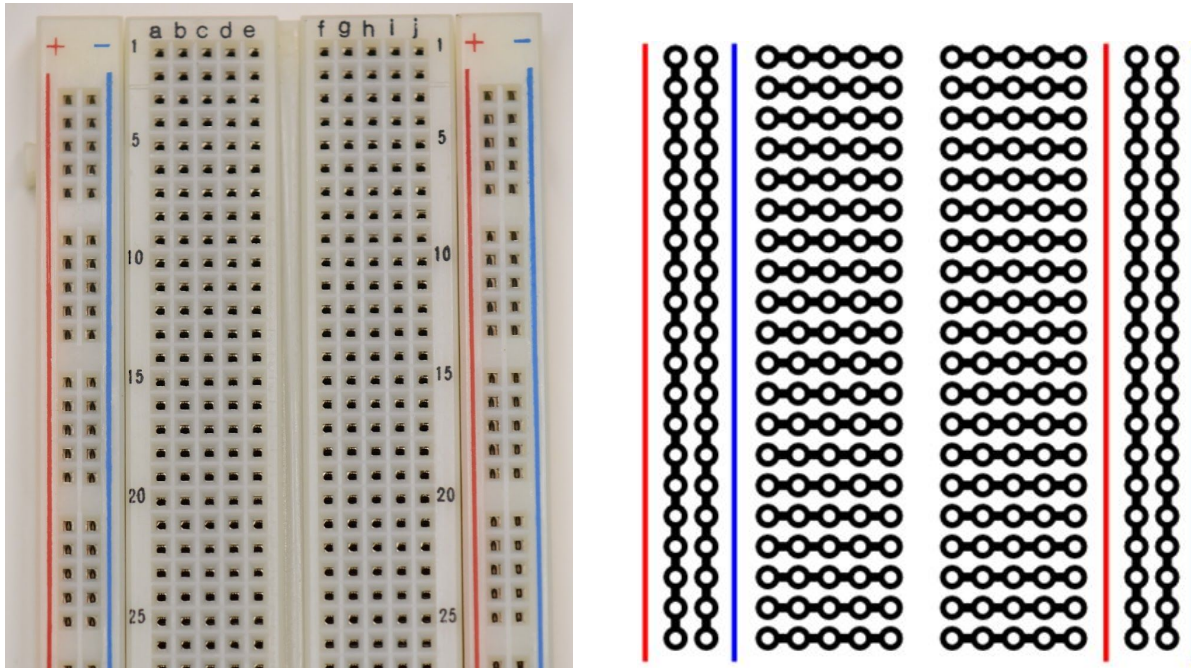

A breadboard is a collection of conducting clips that make it easy to connect wires to components like resistors, LEDs, and Teensy pins. Along the outer edges of the breadboard are long columns of clips called rails. In the middle section of the breadboard are rows of 5 connected holes. The left and right side of the center channel are not connected.

When a component like the Teensy 3.5 is plugged into the breadboard, the rows become connected to the Teensy pins and give several access points to each pin. The pin names are not shown on the Teensy board, you can see them [on the Teensy website](#).

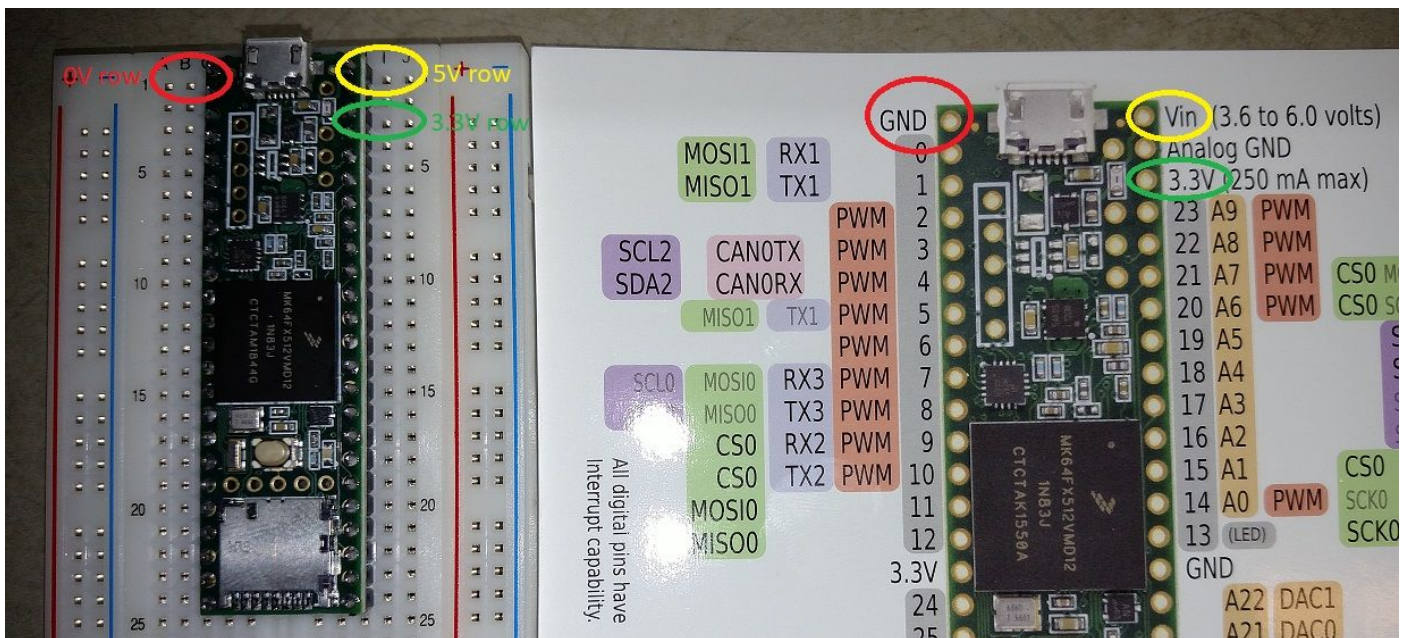

Circuits usually need many access points to power and ground, so wire is used to connect the rails to the power rows to gain more power and ground holes. Make some wires to connect the left **+** rail to 3.3V and the left **-** rail to GND (0V). The color convention is to use **red wire** for 3.3V and **black wire** for Ground, so that you can quickly look at a circuit and debug it later.

Note that the Teensy is supplied with 5V on the Vin pin from the computer using the USB cable, and now the breadboard has access to the computer's 5V line. The computer would be very unhappy if you shorted its 5V (no damage, but the USB port would be disabled and only reenabled by a reboot). Applying a voltage to the 5V connection, say from a 6V pack of AA batteries, would damage the computer's motherboard, so extra care should always be taken when using power from both the computer and an external source.

*Bonus points* for wires that are flush to the board.

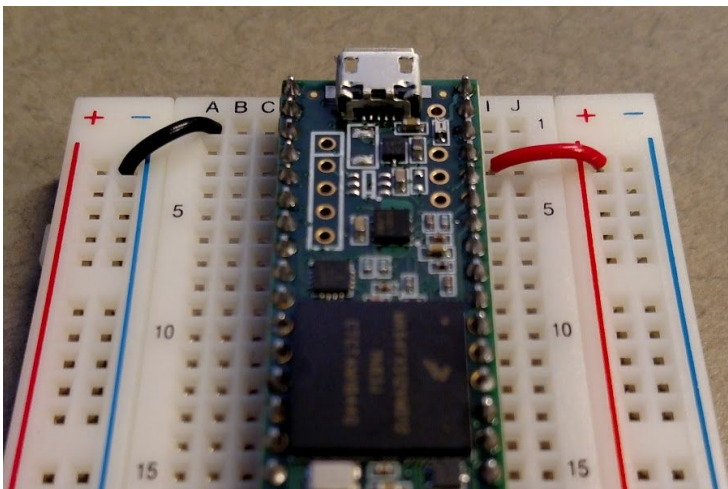

Flush

vs

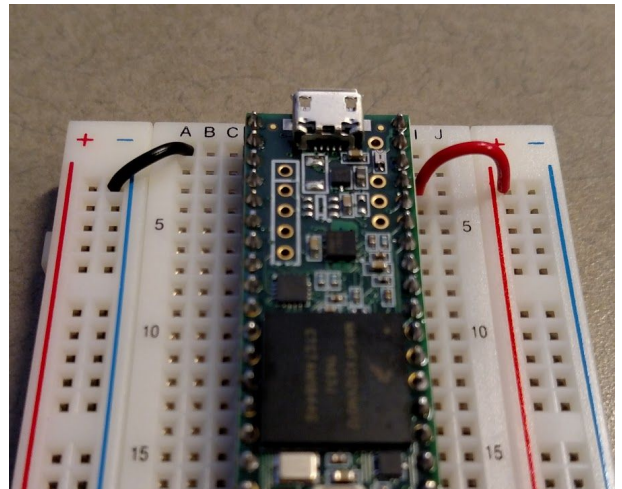

Loopy

*Extra bonus points* for connecting the rails on the left to the rails on the right so that 3.3V and GND are available on both sides of the board.

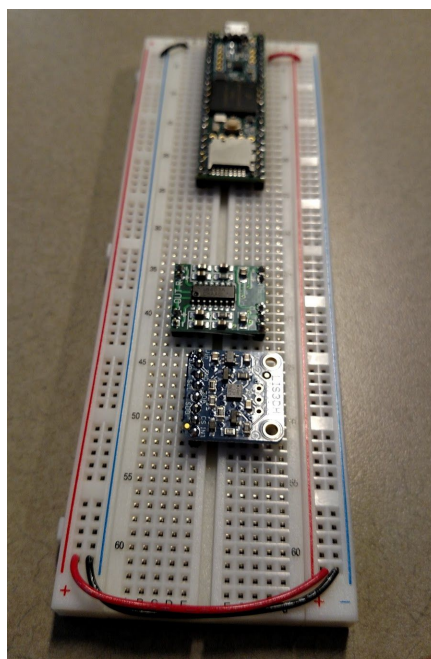

## Electronics: Power an LED

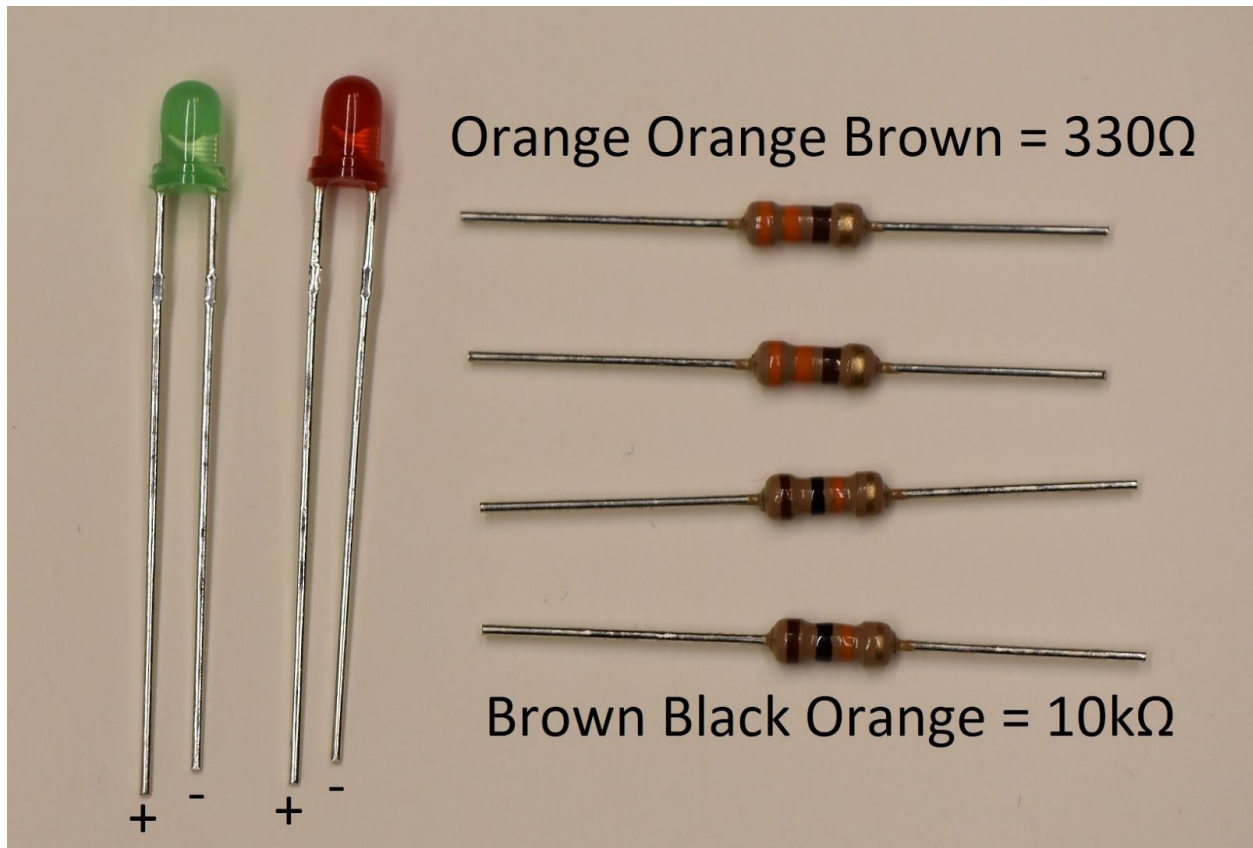

An LED will light when current flows through it, from the positive leg (longer wire) to the negative leg (shorter wire). A resistor in series with the LED is necessary to reduce the current through the LED and prevent it from overheating.

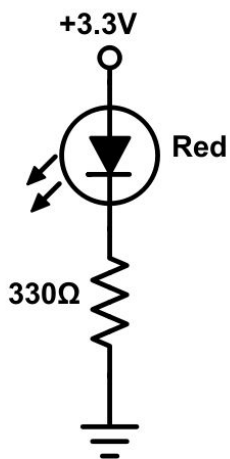

It is important to draw a circuit schematic before building the circuit. The schematic is the reference for what you were supposed to build, and your guide when debugging.

Build this circuit somewhere on your breadboard. What happens when you replace the  $330\Omega$  resistor with the  $10k\Omega$ ?

The schematic does not tell you how to make the connections on the breadboard; there are infinite ways to do that. Use whatever construction you are comfortable with! You can also trim the legs of the LED and resistor to make them less likely to fall out, but try to leave the positive leg of the LED a little longer so you remember which way is positive.

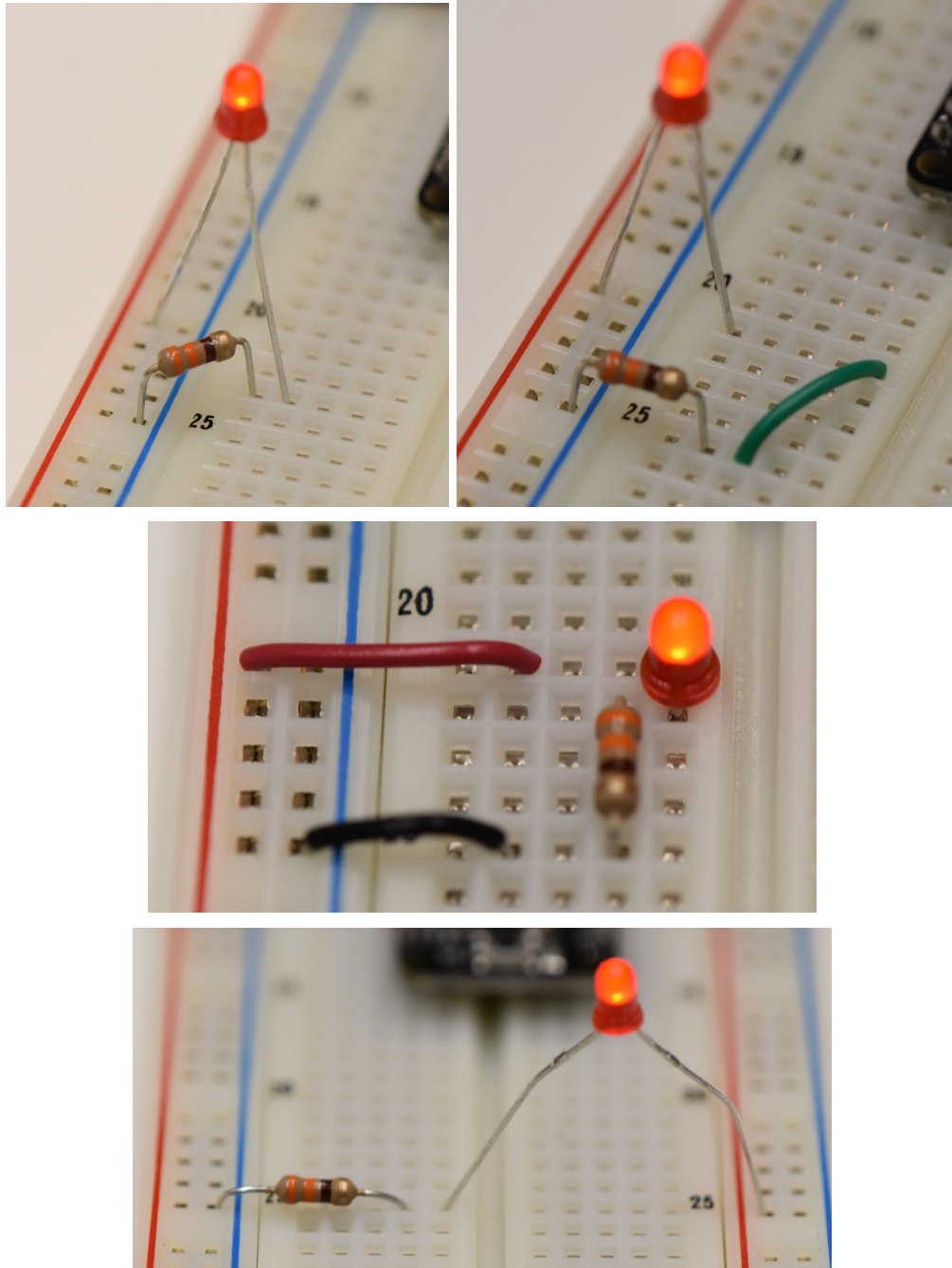

## Electronics: Turn on an LED with a button

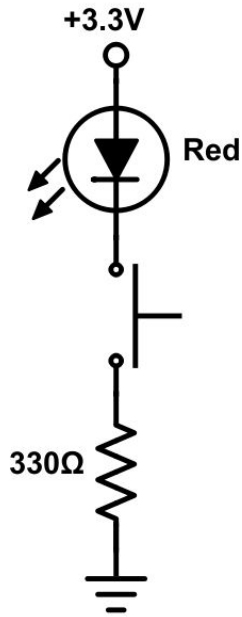

Edit your circuit so that the LED is on only when a push button is pushed.

Do the order of the components matter?

How could you redesign the circuit so that the LED is on only when the button is not pushed?

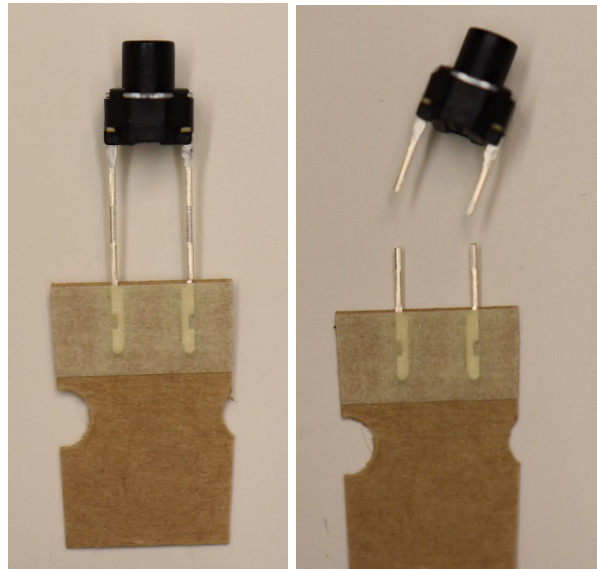

Note that the pushbutton has funny feet that do not fit in the breadboard. Cut them off!

Why does the following circuit not function?

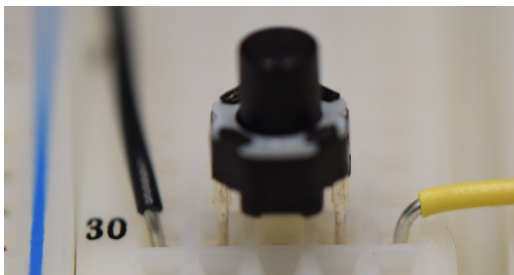

## Arduino programming: Blink an LED

Open the Arduino IDE software. Go to Tools→Board, and select Teensy 3.5.

Arduino programming uses the C/C++ language, with a few adaptations. When the Teensy board is powered, the function `setup()` is called. When `setup()` completes, `loop()` is called. When `loop()` ends, `loop()` is called again, until the board is

- unpowered,
- the reset button is pushed,
- the board is reprogrammed from the IDE.

The program memory is nonvolatile, so the program stays on the Teensy forever, even if it loses power. The variables are volatile memory, and are cleared when the Teensy loses power or is reset.

Global variables, generally frowned upon in C programming, are common on microcontrollers like Teensy, and are usually defined above `setup()`. Line comments start with `//` and block comments appear between `/*` and `*/`.

```
sketch_mar22a §
/*
 * block comment
 */

// global variables up here

void setup() {
  // put your setup code here, to run once:
}

void loop() {
  // put your main code here, to run repeatedly:
}

|
```



The Arduino IDE contains many examples. Go to File→Examples→0.1Basics→Blink.

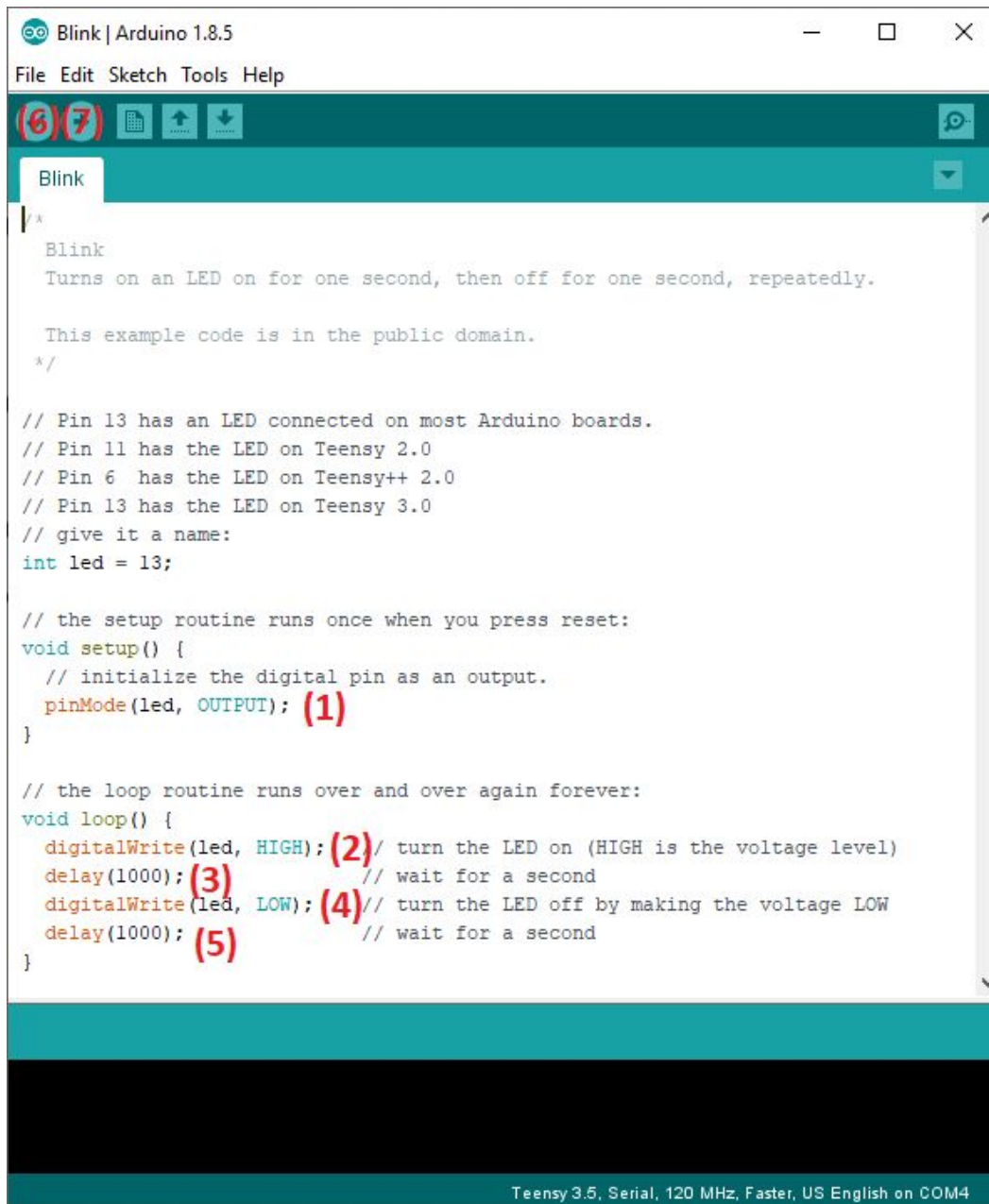

```
Blink | Arduino 1.8.5
File Edit Sketch Tools Help

(6) (7) [Compile] [Upload] [Download]

Blink
/*
 * Blink
 * Turns on an LED on for one second, then off for one second, repeatedly.
 *
 * This example code is in the public domain.
 */

// Pin 13 has an LED connected on most Arduino boards.
// Pin 11 has the LED on Teensy 2.0
// Pin 6 has the LED on Teensy++ 2.0
// Pin 13 has the LED on Teensy 3.0
// give it a name:
int led = 13;

// the setup routine runs once when you press reset:
void setup() {
  // initialize the digital pin as an output.
  pinMode(led, OUTPUT); (1)
}

// the loop routine runs over and over again forever:
void loop() {
  digitalWrite(led, HIGH); (2) // turn the LED on (HIGH is the voltage level)
  delay(1000); (3) // wait for a second
  digitalWrite(led, LOW); (4) // turn the LED off by making the voltage LOW
  delay(1000); (5) // wait for a second
}

Teensy 3.5, Serial, 120 MHz, Faster, US English on COM4
```

The Teensy 3.5 board has an LED soldered to pin 13. The blink code (1) sets pin 13 as an output pin, (2) turns the pin on, (3) waits 1000 ms, (4) turns the pin off, (5) waits 1000 ms, and continues forever. Change the `delay()` calls to 100 ms, and (6) compile the code (check mark button). (7) Upload the code to the Teensy (right-wards arrow button, which opens and runs the Teensyduino add-on program), and observe the new blinking rate. In the future, it is not necessary to compile the code before uploading, the upload button does both.

Copy the code, make a new file, and paste the code in. Save it (the default location is `/Documents/Arduino`, leave it there). Choose a new pin, and edit the code to use the new pin. Build a circuit with an LED on that pin, and blink it at 4 Hz.

Draw your circuit diagram:

## Arduino programming: Read a button and turn on an LED

Build the following push button circuit.

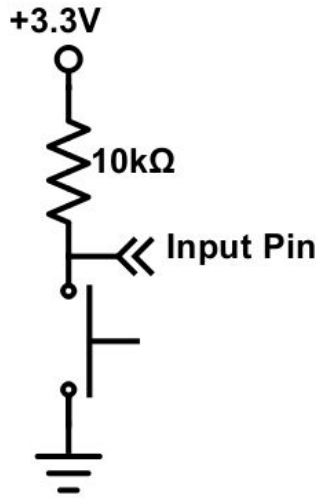

What voltage does the circuit output to the input pin when the button is not pressed? When the button is pressed?

Choose a pin to read the button voltage. In `setup()`, add a line that will initialize the pin as `INPUT`.

In `loop()`, declare a variable that will store the value of the button, like

```
int b;
```

and read the state of the pin into `b`:

```
b = digitalRead(pin_number);
```

where `pin_number` is the number of the pin you plugged into.

`digitalRead()` will return a 0 when the voltage is 0V and a 1 when the voltage is 3.3V.

After reading the button voltage into `b`, use an `if()` statement to determine if the button is pressed, and if it is, turn on the LED, and if it is not, turn off the LED.

Do you know the syntax for an `if()` statement in C? Check the Arduino reference guide at <https://www.arduino.cc/reference/en/>.

## Arduino programming: Read a potentiometer and print the voltage to the computer

A potentiometer is a variable resistor knob with three legs. When the bottom and top legs are attached to Ground and 3.3V, the middle leg will output a voltage from 0V to 3.3V that is proportional to the angle of the knob. Potentiometers are usually limited to 180 degrees of rotation.

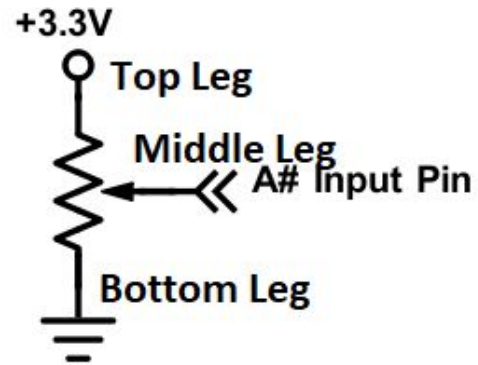
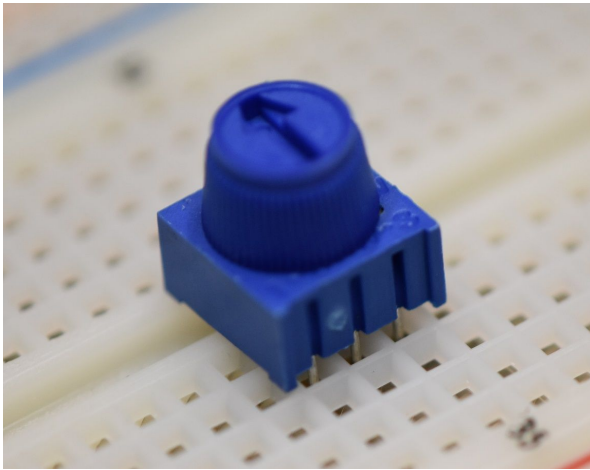

The Teensy 3.5 can read voltages from 0V to 3.3V on pins that begin with A (A0 to A9, A12 to A22). Build the potentiometer circuit and connect the output voltage to an A pin.

The function `analogInput(pin_name)` will return an integer from 0 to 1023 (0 for 0V, 1023 for 3.3V). The `pin_name` is the name of the pin you plugged into (example A0). The A pins do not need to be initialized with `pinMode()`. In `loop()`, declare an `int` variable, and set its value to the analog value of the potentiometer voltage. Change your `if()` statement so that if the potentiometer voltage is above 2.5V the LED is on, otherwise it is off. This is an example of 1 LED debugging!

The Teensy has the ability to turn the numeric value of a variable into text characters and print them to the computer. This occurs over USB, but is called Serial communication after the type of legacy functions the computer uses. To enable Serial communication, enable the Serial module in `setup()` by calling the function `Serial.begin(9600)`; In `loop()`, use the function `Serial.println(variable_name)`; to turn the value of `variable` into text and send the text characters to the computer. Upload the code, and open the Serial Monitor to see the data stream.

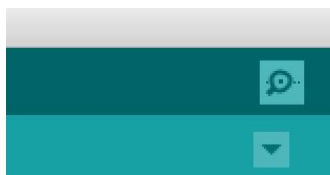

The Serial Monitor button in the top right of the IDE, looks like a magnifying glass

Turn the potentiometer to see the value change.

The Teensy is sending the value as fast as possibly can, which may upset your computer. Add a `delay()` at the end of `loop()` to slow the communication down to 10 Hz.

Also try the Serial Plotter in Tools→Serial Plotter.

## Arduino programming: Read a potentiometer and set the brightness of an LED

Most Arduino boards lack the ability to output analog voltages (voltages that are between 0V and 3.3V). There is a function called `analogWrite(pin, value)`, but it actually outputs a square wave at a high frequency, blinking the pin so fast that it appears to be analog (this is typically called pulse width modulation, or PWM). `value` can take integer values between 0 and 255, and only pins labeled with PWM can be called with `analogWrite()` on the Teensy (on other Arduino boards, the pins are labeled with a ~).

Connect your LED circuit to a PWM capable pin and use `analogWrite()` to set the brightness of the LED proportional to the angle of the potentiometer.

- Did you draw a circuit diagram below:
- Did you remember `pinMode()` for your PWM pin?
- What is weird about the value you get from `analogRead()` and the value you use in `analogWrite()`? Use `Serial.println()` statements to help you figure it out.

## Arduino programming: Using an internal library to control the position of an RC servo

A Remote Control style Servomotor is an inexpensive way to get position control of a motor. The RC servo has a built in controller, brushed DC motor, gears, and potentiometer. It reads its own position and forces it to match the commanded position told to it by the Teensy.

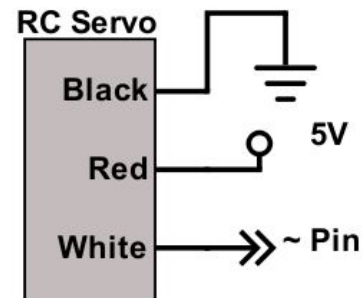
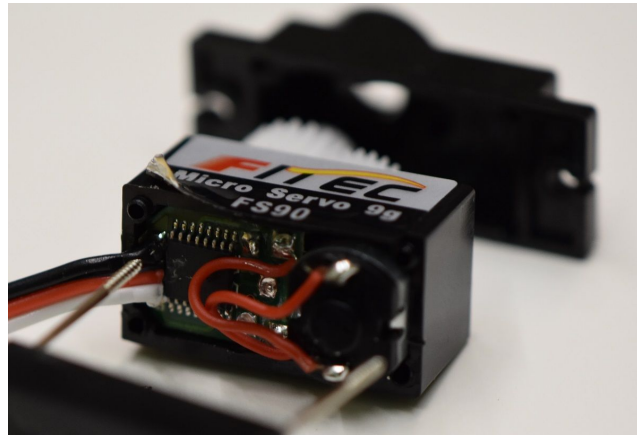
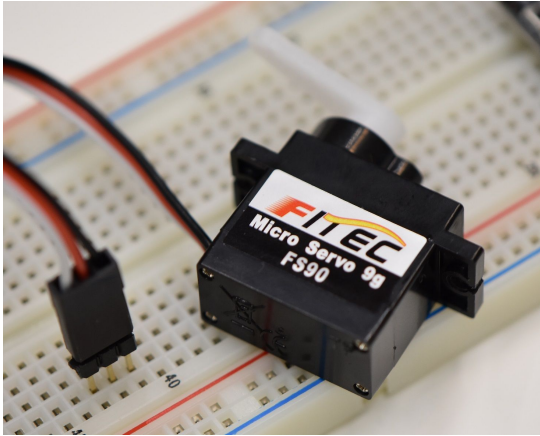

Connect the black wire of the servo to Ground and the red wire to 5V from the Vin pin. The white wire goes to a PWM capable pin on the Teensy. Larger RC servos can draw more current than USB can supply and need an external power supply, usually 4.8-6V.

The voltage signal that commands a desired angle to the servo uses a library, like the way Serial communication works. The servo library is not included in the code by default, but it is preinstalled with the IDE, so you can use it by adding `#include <Servo.h>` at the top of your code. Declare a global variable to represent the servo above `setup()`, like `Servo myServo;` In `setup()`, assign the servo variable the PWM pin you connect the servo to, like `myServo.attach(pin_number);`

You can set the position of the servo by using `myServo.write(angle)`, where `angle` is an integer from 0 to 180, representing 0 degrees to 180 degrees.

Edit your code so that when the button is pushed, set the angle of the servo proportionally to the angle of the potentiometer. Having trouble? Print the value of the angle to the Serial Monitor to check your math.

Try holding down the button and turning the potentiometer, and try turning the potentiometer and tapping the button. How fast can the motor move?

## Arduino programming: Using a library to control the color of an RGB LED

The WS2812B is an addressable RGB LED that is commonly known as a NeoPixel. Using one pin from the Teensy, you can control the brightness and color of hundreds of NeoPixels. You can purchase NeoPixels on flexible tape, stiff lines, arcs, or panels, or a variety of different configurations, and make cool displays and lighting effects.

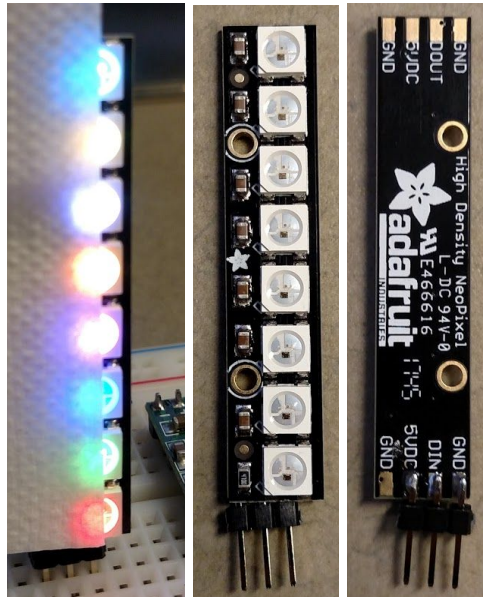

The NeoPixel requires a connection to 5V, Ground, and a Teensy pin to the WS2812B DIN pin (your Neopixel breakout board may look slightly different). If you had more NeoPixels, DOUT of the first NeoPixel would be connected to DIN of the second, and so on.

To control over the NeoPixel in your code:

- Include the library at the top: `#include <FastLED.h>`
- Create definitions of the number of NeoPixels you have and which pin they are connected to:
  - `#define NUM_LEDS 8`
  - `#define NEOPIXEL_PIN 33`
- Create a global variable to represent the NeoPixels: `CRGB leds[NUM_LEDS];`
- Initialize the variable in `setup()` using:
  - `FastLED.addLeds<WS2812B, NEOPIXEL_PIN, GRB>(leds, NUM_LEDS).setCorrection( TypicalLEDStrip );`
- Set the color of each `leds[]`, starting at 0, in `loop()` using:
  - `leds[0].r = 5;`
  - `leds[0].g = 0;`
  - `leds[0].b = 0;`
  - `...`
  - `FastLED.show();`

```

#include <FastLED.h>
#define NUM_LEDS 8
#define NEOPIXEL_PIN 33

CRGB leds[NUM_LEDS];

void setup() {
  FastLED.addLeds<WS2812B, NEOPIXEL_PIN, GRB>(leds, NUM_LEDS).setCorrection( TypicalLEDStrip );
}

void loop() {
  for (int k = 0; k < 255; k++) {
    for (int i = 0; i < NUM_LEDS; i++) {
      leds[i].r = k;
      leds[i].g = k;
      leds[i].b = k;
      FastLED.show();
      delay(3);
    }
  }
}

```

In the same place where you set the position of the servo, set the brightness of the red portion of the LED proportional to the potentiometer angle.

Still have time left? Edit the code so that:

- The NeoPixel outputs a color proportional to the angle of the potentiometer, initially red
- Every time the button is pushed, toggle the color of the NeoPixel (red to green to blue to red, ...)
  - This is trickier than it sounds. You will need a variable to remember the current color of the NeoPixel, and an `if()` statement that can detect if the button was just pressed, as opposed to is currently pressed.