

SERIES: 6 W wall plug | **DESCRIPTION:** SWITCHING POWER SUPPLY

FEATURES

- Up to 6 W power
- Compact size
- Single output from 3 ~ 24 V
- Overload, over voltage, and short circuit protections
- 100 ~ 132 Vac input voltage
- meets EISA / efficiency level IV regulations
- custom designs available

V-Infinity

MODEL	output voltage nominal (Vdc)	output current max (A)	output power max (W)	ripple and noise¹ max (mVp-p)	efficiency level
EPS030100	3	1	3	100	IV
EPS033100	3.3	1	3.3	100	IV
EPS045100	4.5	1	4.5	100	V
EPS050100	5	1	5	100	V
EPS060100	6	1	6	100	V
EPS090066	9	0.66	6	100	V
EPS120050	12	0.5	6	150	V
EPS150040	15	0.4	6	150	V
EPS180033	18	0.33	6	180	V
EPS240025	24	0.25	6	240	IV

Notes: 1. At full load, 100 ~ 132 Vac input, 20 MHz bandwidth oscilloscope, each output terminated with 10 μ F aluminum electrolytic and 0.1 μ F ceramic capacitors.

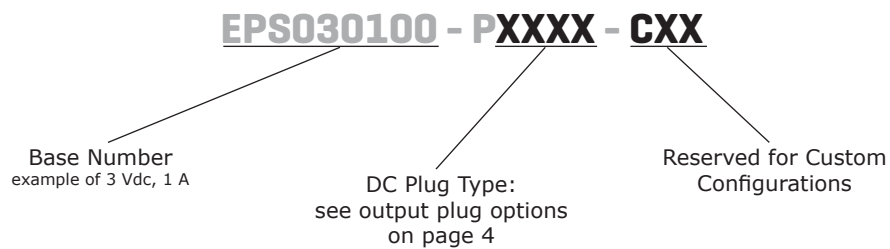
PART NUMBER KEY

INPUT

parameter	conditions/description	min	typ	max	units
voltage		100		132	Vac
frequency		47		63	Hz
input current				1	A
inrush current	120 Vac, inrush lasts no longer than 0.5 ms before settling to steady state current			40	A
no load power consumption				0.5	W

OUTPUT

parameter	conditions/description	min	typ	max	units
line regulation			±1		%
load regulation			±5		%
temperature coefficient	0 ~ 40°C, full load, after initial 1 hour warm-up		±0.02		%/°C
start-up time	time needed to reach regulation			3	s
hold-up time	at 115 Vac, full load	10			ms

PROTECTIONS

parameter	conditions/description	min	typ	max	units
over voltage protection	clamped by internal protection zener				
overload protection	Fold-back current limiting starts at 105 ~ 160% of the rated output current. Auto-recovery. Long term exposure to overload condition may reduce product reliability.				
short circuit protection	Continuous, auto-recovery upon removal of short				

SAFETY & COMPLIANCE

parameter	conditions/description	min	typ	max	units
isolation voltage	input to output at 10 mA for 1 minute			3,000	Vac
isolation resistance	input to output at 500 Vdc	100			MΩ
safety approvals	UL/cUL 1310				
EMI standard	FCC part 15 class B				
leakage current	at 120 Vac			0.5	mA
class 2 power supply	yes				
MTBF	at 25°C, per MIL-HDBK-217E	240,000			hours
RoHS compliant	yes				

ENVIRONMENTAL

parameter	conditions/description	min	typ	max	units
operating temperature		0		40	°C
storage temperature		-10		70	°C
operating humidity		20		80	%
storage humidity		10		90	%

MECHANICAL DRAWING

input plug	US blade
case size	62.3 L x 26.8 W x 42 H mm tolerance: ±1 mm

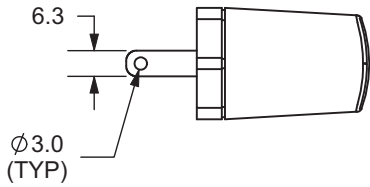
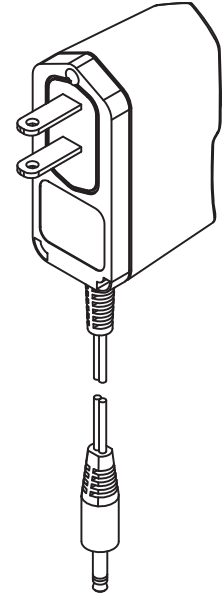
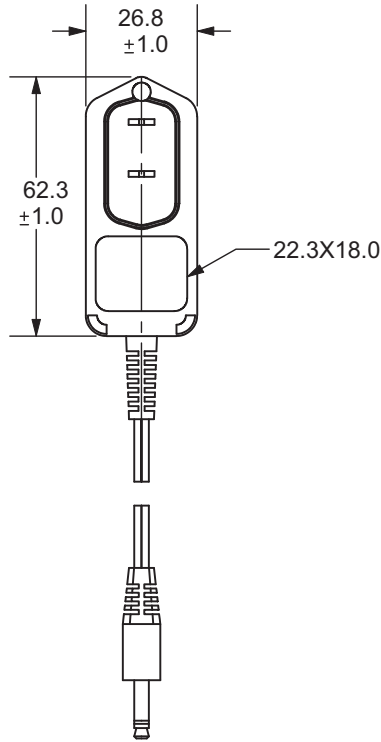
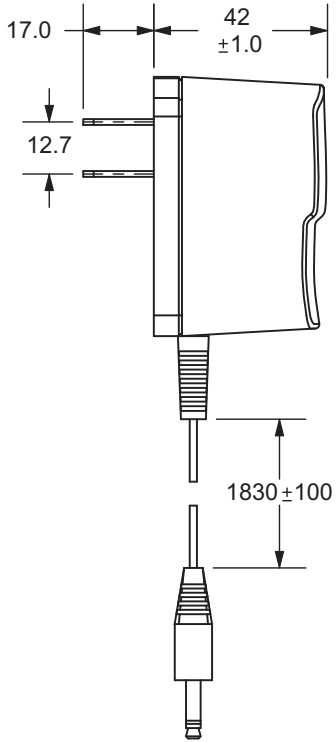

Units: mm

Tolerance:
X.X ±0.5mm
X.XX ±0.03mm

NOTE 1: THIS POWER UNIT IS INTENDED TO BE CORRECTLY ORIENTED IN A VERTICAL OR FLOOR MOUNT POSITION.

OUTPUT PLUG OPTIONS

3.5 mm Phono Plug

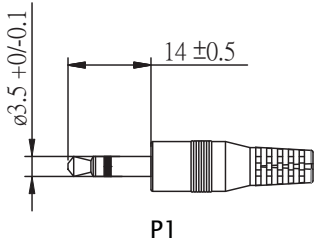

P1

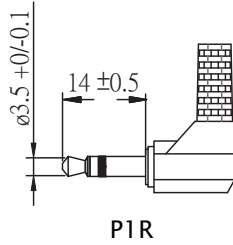

P1R

*Tip positive

Standard DC Plug

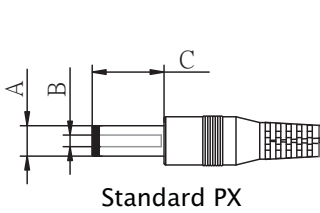

Standard PX

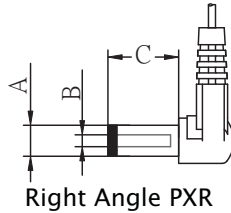

Right Angle PXR

	A	B	C	Unit
P5 ¹ /P5R	5.5	2.1	12	mm
P6/P6R	5.5	2.5	12	mm
P7/P7R	3.5	1.3	9.5	mm
P8/P8R	3.8	1.35	9.5	mm
P9/P9R	3.8	1.05	9.5	mm

Notes: 1. dc plug length for EPS050100-P5P is 9.5 mm

Locking DC Plug

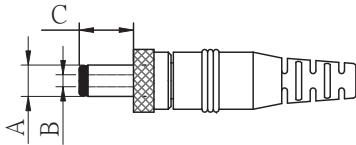

	A	B	C	Unit
P10	5.5	2.1	9.5	mm
P11	5.5	2.5	9.5	mm

EIAJ Plugs

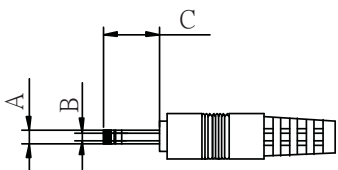

Standard PXX

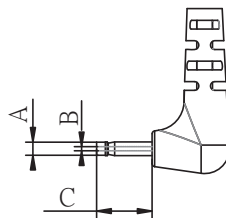

Right Angle PXXR

	EIAJ	A	B	C	D	Unit
P12/P12R	EIAJ-1	2.35	0.7	9.5	NA	mm
P13/P13R	EIAJ-2	4.0	1.7	9.5	5.0	mm
P14/P14R	EIAJ-3	4.75	1.7	9.5	5.0	mm

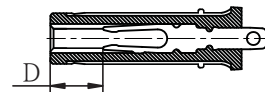

Stripped and Tinned

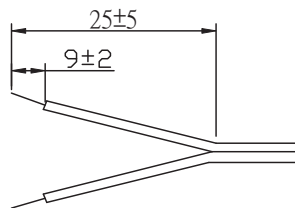

DC PLUG TYPE

ST
|
stripped and tinned

PXX X X

Plug type Plug angle:
"blank" = standard
R = right angle Plug polarity:
"blank" = N/A
P = center positive ⊖ — ⊕
N = center negative ⊕ — ⊖

REVISION HISTORY

rev.	description	date
1.0	initial release	06/29/2006
1.01	applied new spec template	12/28/2010
1.02	removed multiple models, applied new spec template	05/26/2011

The revision history provided is for informational purposes only and is believed to be accurate.



CUI INC[®]

Headquarters
20050 SW 112th Ave.
Tualatin, OR 97062
800.275.4899

Fax 503.612.2383
cui.com
techsupport@cui.com

This device complies with part 15 of the FCC Rules. Operation is subject to the following two conditions:

- (1) This device may not cause harmful interference, and
- (2) this device must accept any interference received, including interference that may cause undesired operation.

CUI offers a two (2) year limited warranty. Complete warranty information is listed on our website.

CUI reserves the right to make changes to the product at any time without notice. Information provided by CUI is believed to be accurate and reliable. However, no responsibility is assumed by CUI for its use, nor for any infringements of patents or other rights of third parties which may result from its use.

CUI products are not authorized or warranted for use as critical components in equipment that requires an extremely high level of reliability. A critical component is any component of a life support device or system whose failure to perform can be reasonably expected to cause the failure of the life support device or system, or to affect its safety or effectiveness.