

DS2003 High Current/Voltage Darlington Drivers

General Description

The DS2003 is comprised of seven high voltage, high current NPN Darlington transistor pairs. All units feature common emitter, open collector outputs. To maximize their effectiveness, these units contain suppression diodes for inductive loads and appropriate emitter base resistors for leakage.

The DS2003 has a series base resistor to each Darlington pair, thus allowing operation directly with TTL or CMOS operating at supply voltages of 5.0V.

The DS2003 offers solutions to a great many interface needs, including solenoids, relays, lamps, small motors, and

LEDs. Applications requiring sink currents beyond the capability of a single output may be accommodated by paralleling the outputs.

Features

- Seven high gain Darlington pairs
- High output voltage ($V_{CE} = 50V$)
- High output current ($I_C = 350\text{ mA}$)
- TTL, PMOS, CMOS compatible
- Suppression diodes for inductive loads
- Extended temperature range

Connection Diagram

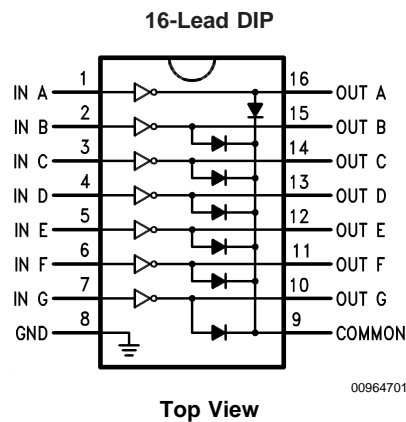

Order Numbers

N Package Number N16E	M Package Number M16A
DS2003TN	DS2003TM
DS2003CN	DS2003CM

Absolute Maximum Ratings (Note 1)

If Military/Aerospace specified devices are required, please contact the National Semiconductor Sales Office/Distributors for availability and specifications.

Storage Temperature Range	-65°C to +150°C
Operating Temperature Range	
DS2003TN, DS2003TM	-40°C to +105°C
DS2003CN, DS2003CM	0°C to +85°C
Lead Temperature	
Soldering, 10 seconds	265°C

N16E Package	1330 mW
M16A Package	770 mW
Input Voltage	-0.3V to 30V
Output Voltage	55V
Emitter-Base Voltage	6.0V
Continuous Collector Current	500 mA
Continuous Base Current	25 mA

Note: *Derate N16E package 13.3 mW/°C for T_A above 25°C. Derate M16A package 7.7 mW/°C for T_A above 25°C.

Maximum Power Dissipation* at T_A
= 25°C

Electrical Characteristics

$T_A = 25^\circ\text{C}$, unless otherwise specified (Note 2)

Symbol	Parameter	Conditions	Min	Typ	Max	Units
I_{CEX}	Output Leakage Current	$T_A = 25^\circ\text{C}$, $V_{CE} = 50\text{V}$ (Figure 1)			20	μA
		$T_A = 85^\circ\text{C}$, $V_{CE} = 50\text{V}$ (Figure 1) for DS2003CN, DS2003CM			100	
		$T_A = 105^\circ\text{C}$, $V_{CE} = 50\text{V}$ (Figure 1) for DS2003TN, DS2003TM			150	
$V_{CE(Sat)}$	Collector-Emitter Saturation Voltage	$I_C = 350\text{ mA}$, $I_B = 500\ \mu\text{A}$ (Figure 3) (Note 3)		1.25	1.6	V
		$I_C = 200\text{ mA}$, $I_B = 350\ \mu\text{A}$ (Figure 3)		1.1	1.3	
		$I_C = 100\text{ mA}$, $I_B = 250\ \mu\text{A}$ (Figure 3)		0.9	1.1	
$I_{I(ON)}$	Input Current	$V_I = 3.85\text{V}$ (Figure 4)		0.93	1.35	mA
$I_{I(OFF)}$	Input Current (Note 4)	$T_A = 85^\circ\text{C}$ for DS2003CN, DS2003CM $I_C = 500\ \mu\text{A}$ (Figure 5)	50	100		μA
$V_{I(ON)}$	Input Voltage (Note 5)	$V_{CE} = 2.0\text{V}$, $I_C = 200\text{ mA}$ (Figure 6)			2.4	V
		$V_{CE} = 2.0\text{V}$, $I_C = 250\text{ mA}$ (Figure 6)			2.7	
		$V_{CE} = 2.0\text{V}$, $I_C = 300\text{ mA}$ (Figure 6)			3.0	
C_I	Input Capacitance			15	30	pF
t_{PLH}	Turn-On Delay	$0.5 V_I$ to $0.5 V_O$			1.0	μs
t_{PHL}	Turn-Off Delay	$0.5 V_I$ to $0.5 V_O$			1.0	μs
I_R	Clamp Diode Leakage Current	$V_R = 50\text{V}$ (Figure 7) $T_A = 25^\circ\text{C}$			50	μA
		$T_A = 85^\circ\text{C}$			100	μA
V_F	Clamp Diode Forward Voltage	$I_F = 350\text{ mA}$ (Figure 8)		1.7	2.0	V

Note 1: "Absolute Maximum Ratings" are those values beyond which the safety of the device cannot be guaranteed. They are not meant to imply that the devices should be operated at these limits. The tables of "Electrical Characteristics" provide conditions for actual device operation.

Note 2: All limits apply to the complete Darlington series except as specified for a single device type.

Note 3: Under normal operating conditions these units will sustain 350 mA per output with $V_{CE(Sat)} = 1.6\text{V}$ at 70°C with a pulse width of 20 ms and a duty cycle of 30%.

Note 4: The $I_{I(OFF)}$ current limit guaranteed against partial turn-on of the output.

Note 5: The $V_{I(ON)}$ voltage limit guarantees a minimum output sink current per the specified test conditions.

Typical Performance Characteristics

Collector Current vs Saturation Voltage

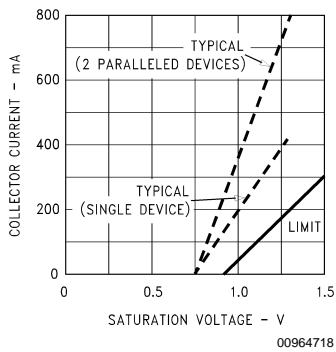

Collector Current vs Input Current

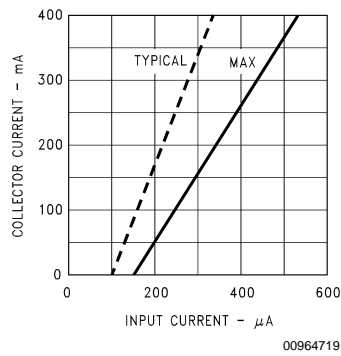

Input Current vs Input Voltage

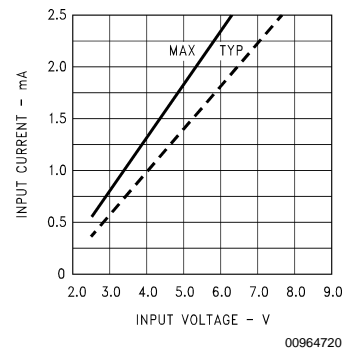

Peak Collector Current vs Duty Cycle and Number of Outputs (Molded Package)

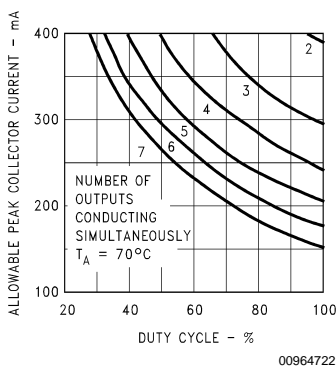

Peak Collector Current vs Duty Cycle and Number of Outputs (Ceramic Package)

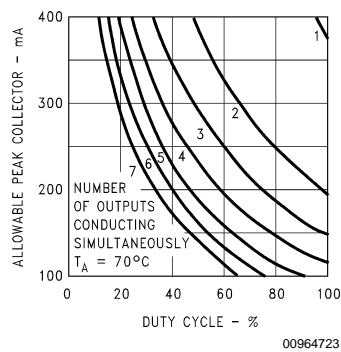

Equivalent Circuits

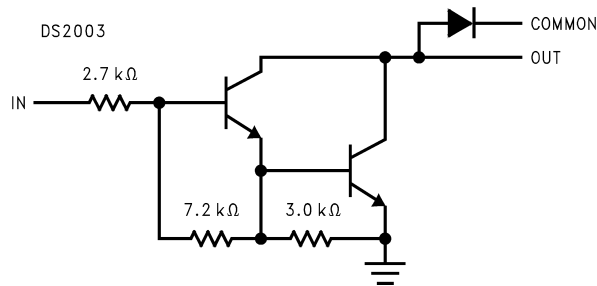

Test Circuits

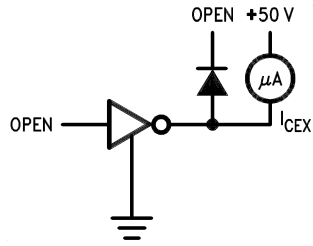

00964707

FIGURE 1.

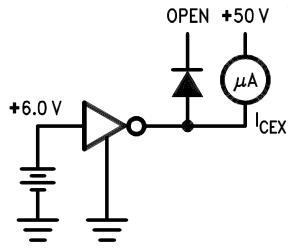

00964708

FIGURE 2.

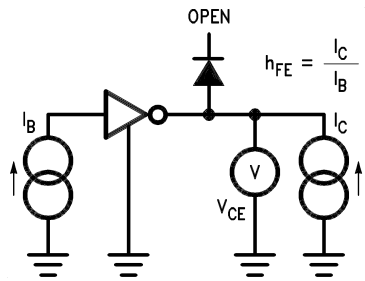

00964709

FIGURE 3.

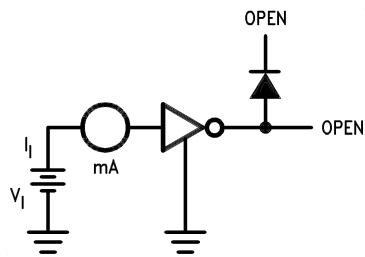

00964710

FIGURE 4.

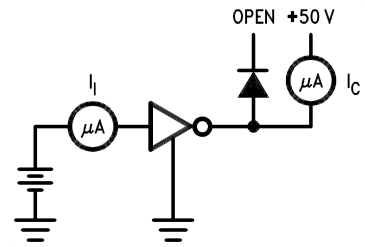

00964711

FIGURE 5.

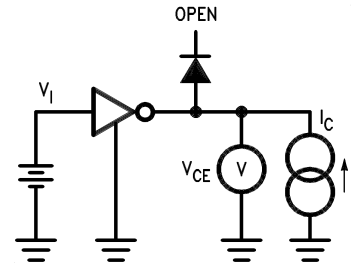

00964712

FIGURE 6.

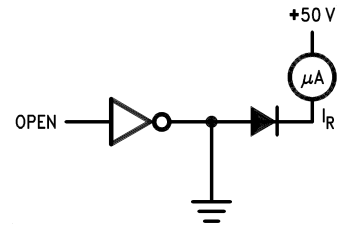

00964713

FIGURE 7.

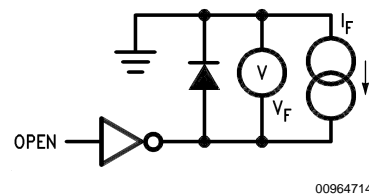

00964714

FIGURE 8.

Physical Dimensions inches (millimeters) unless otherwise noted

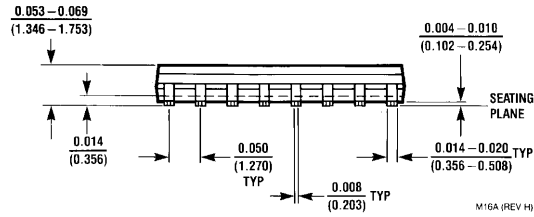
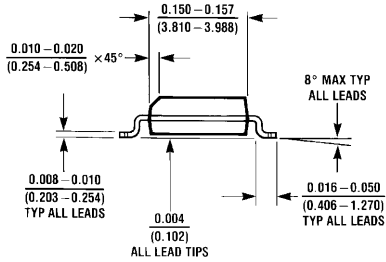
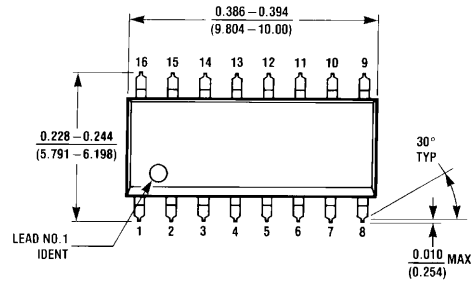

Surface Mount Package (M)
Order Number DS2003CM, DS2003TM
NS Package Number M16A

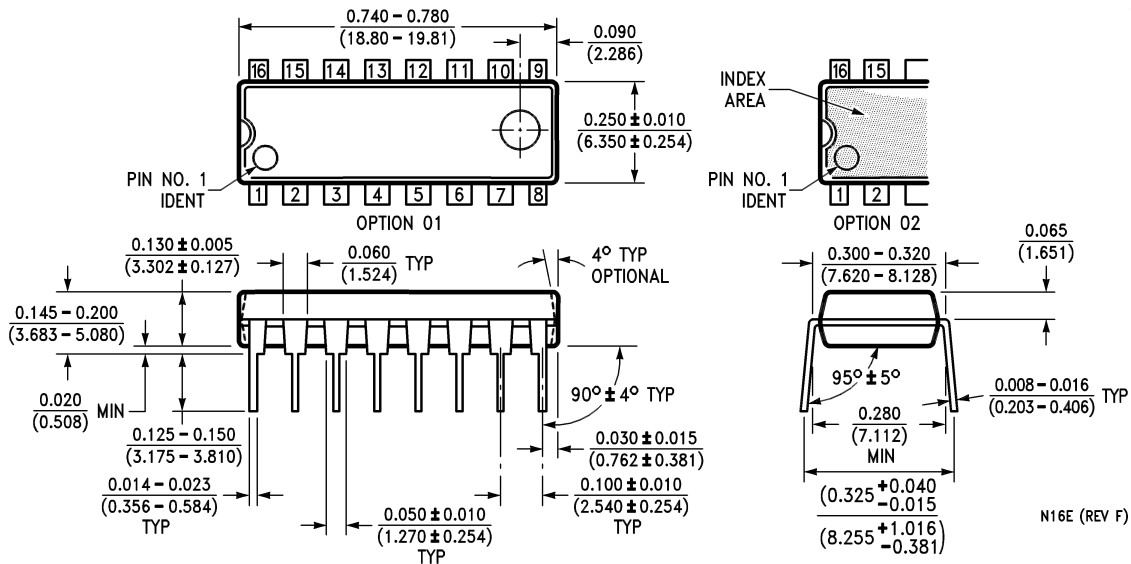

Molded Dual-In-Line Package (N)
Order Number DS2003CN, DS2003TN
NS Package Number N16E

Notes

LIFE SUPPORT POLICY

NATIONAL'S PRODUCTS ARE NOT AUTHORIZED FOR USE AS CRITICAL COMPONENTS IN LIFE SUPPORT DEVICES OR SYSTEMS WITHOUT THE EXPRESS WRITTEN APPROVAL OF THE PRESIDENT AND GENERAL COUNSEL OF NATIONAL SEMICONDUCTOR CORPORATION. As used herein:

1. Life support devices or systems are devices or systems which, (a) are intended for surgical implant into the body, or (b) support or sustain life, and whose failure to perform when properly used in accordance with instructions for use provided in the labeling, can be reasonably expected to result in a significant injury to the user.
2. A critical component is any component of a life support device or system whose failure to perform can be reasonably expected to cause the failure of the life support device or system, or to affect its safety or effectiveness.



National Semiconductor Corporation
Americas
Email: support@nsc.com

www.national.com

National Semiconductor Europe

Fax: +49 (0) 180-530 85 86
Email: europe.support@nsc.com
Deutsch Tel: +49 (0) 69 9508 6208
English Tel: +44 (0) 870 24 0 2171
Français Tel: +33 (0) 1 41 91 8790

National Semiconductor Asia Pacific Customer Response Group

Tel: 65-2544466
Fax: 65-2504466
Email: ap.support@nsc.com

National Semiconductor Japan Ltd.

Tel: 81-3-5639-7560
Fax: 81-3-5639-7507